

DSPE-256

16 x 16 Audio System

OVERVIEW

DSPECIALISTS audio system DSPE 256 is a compact DSP module based on Analog Devices ADSP21369. It allows processing of up to 16 digital input and 16 digital output channels as TDM or I²S.

Due to its on-board flash memory DSPE-256 is capable to run as a stand-alone system. It can be easily embedded into any customer-specific environment. DSPE-256 is able to work with 3 different clock sources, which makes it to the perfect embedded component for professional audio devices.

DSPE-256 covers a wide range of embedded multi-channel signal processing tasks like audio matrix, filtering, signal analysis, correlation, feature extraction and measurement. The board is accompanied with hardware drivers and a software framework. For audio applications there is a wide range of approved standard library functions and a graphical user interface (GUI) available.

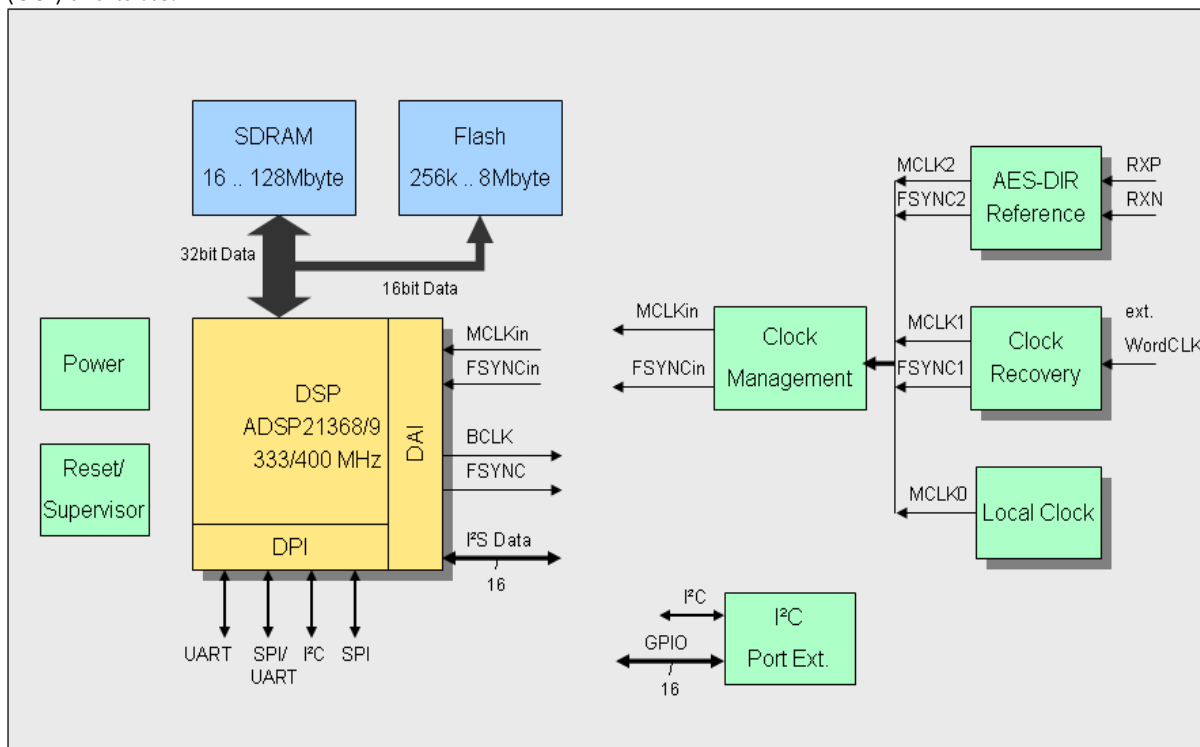

KEY FEATURES

- Stand-alone 32-bit DSP system
- Digital inputs and outputs as TDM or I²S
- Adaptable to customer-specific hardware
- Library for standard audio processing
- Three different clock sources selectable:
 - Word clock, AES/EBU reference, local clock
- Software framework for customer-specific algorithms
- Parameter input via PC user interface
- Up to 16 software setups stored in Flash

Technical Specification

- Processor: ADSP21369 / 400 MHz / 32 bit floating point or fixed point, 2.4 GFLOPs
- Memory: 2 Mbit internal SRAM at core speed
up to 128 MByte SDRAM, 32 bit interface, 133 MHz clock frequency
up to 8 MByte Flash, 8 bit interface, speed 70 ns
- Audio channels: 16 x I²S data lines (32 channels), alternatively TDM
up to 192 kHz sample rate
SPDIF transceiver
Four independent asynchronous sample rate converters
- Clock management: On-board master clock
External clock via master clock, word clock or AES11
- Serial interface: UART, I²C, 2 x SPI, 6 x GPIO, LEDs and switches
JTAG connector
- Power supply: 3.3 V (typ. 600mA, max. 2A)
- Outline: 100 mm x 80 mm
All signals at 2 base-board connectors (2 mm pitch, dual row, 50 pins)

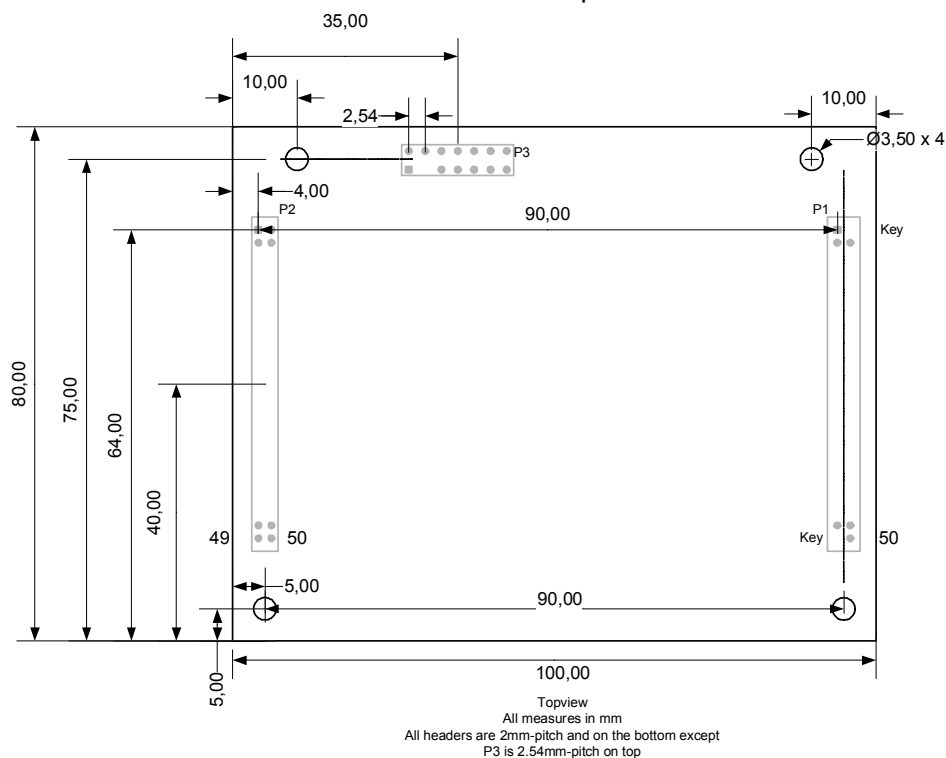

DSPECIALISTS GmbH © 2018

CONTACT US

DSPECIALISTS

Digitale Audio- und Messsysteme GmbH
Helmholtzstr. 2-9 L
10587 Berlin
Germany

Tel: +49 30 467805-0
Fax: +49 30 467805-99
E-mail: sales@dspecialists.de

ABOUT US

The products of DSPECIALISTS are marked by our use of tried and tested standard components. And they can be tailor-made to meet your individual requirements. The range of products and services provided by DSPECIALISTS includes customer-specific modules as well as complete systems. We use DSPs, PCs, micro controllers and programmable logic in our development Work.

VISIT OUR WEBSITE:
www.dspecialists.de